

CDB5460A Evaluation Board and Software

Features

- Direct Shunt Sensor and Current Transformer Interface
- RS-232 Serial Communication with PC
- On-board 80C51 Microcontroller
- On-board Voltage Reference
- Lab Windows/CVI™ Evaluation Software
 - Register Setup & Chip Control
 - FFT Analysis
 - Time Domain Analysis
 - Noise Histogram Analysis
- On-board Data SRAM
- Integrated RS-232 Test Mode
- “Auto-Boot” Demo with serial EEPROM

General Description

The CDB5460A is an inexpensive tool designed to evaluate the functionality and performance of the CS5460A. The CS5460A Data Sheet is supplied in conjunction with the CDB5460A evaluation board.

The evaluation board includes an LT1019 voltage reference, an 80C51 microcontroller, an RS232 transceiver, and firmware. The 8051 controls the serial communication between the evaluation board and the PC via the firmware, enabling quick and easy access to all of the CS5460A's registers and functions.

The CDB5460A includes software for Data Capture, Time Domain Analysis, Histogram Analysis, and Frequency Domain Analysis.

ORDERING INFORMATION

CDB5460A

Evaluation Board

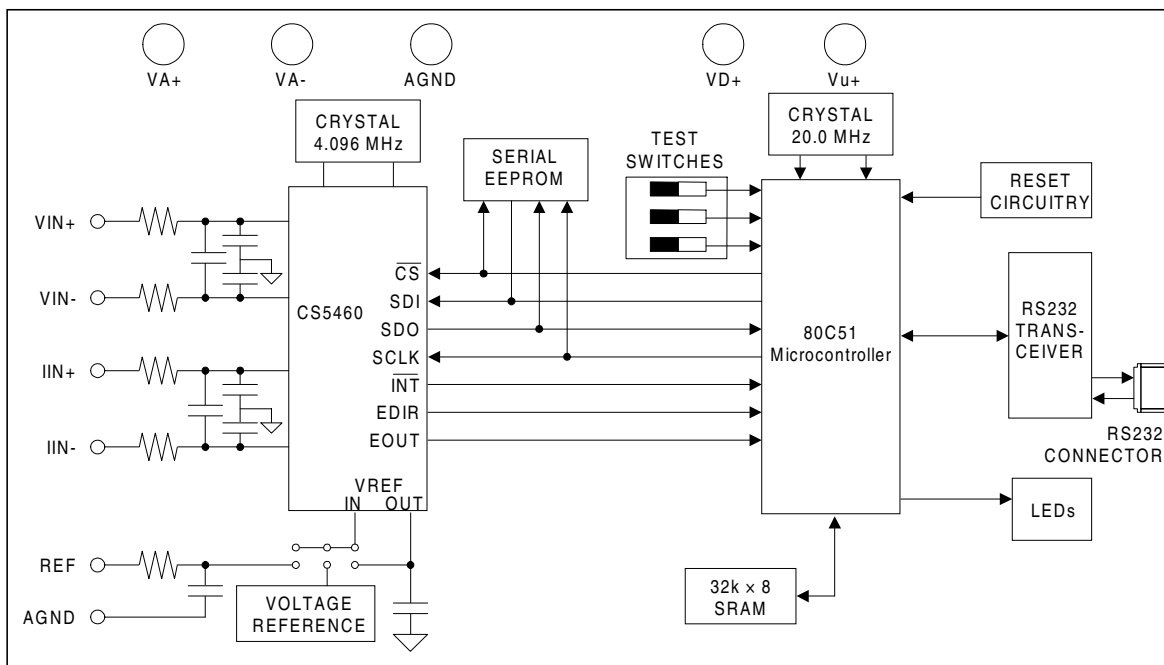

TABLE OF CONTENTS

1. HARDWARE	5
1.1 Introduction	5
1.2 Evaluation Board Overview	5
1.2.1 Analog Section	5
1.2.2 Digital Section	6
1.2.3 Power Supply Section	6
1.3 Using the Evaluation Board	6
2. SOFTWARE	8
2.1 Installation Procedure	9
2.2 Using the Software	9
2.3 Selecting and Testing a COM Port	9
2.4 Register Access in the Setup Window	10
2.4.1 Refresh Screen Button	10
2.4.2 CS5460A Crystal Frequency	10
2.4.3 Configuration Register	10
2.4.4 Mask Register / Status Register	11
2.4.5 Cycle Count / Pulse Rate / Time Base Registers	11
2.4.6 Control Register	12
2.5 Calibration Window	12
2.5.1 Offset / Gain Register	12
2.5.2 Performing Calibrations	12
2.6 Conversion Window	13
2.6.1 Single Conversion Button	14
2.6.2 Continuous Conversions Button	14
2.6.3 Re-Initialize Serial Port Button	14
2.6.4 Standby / Sleep Mode Buttons	14
2.6.5 Power Up Button	14
2.7 Viewing Pulse Rate Output Data	14
2.7.1 Integration Period Box	15

Contacting Cirrus Logic Support

For a complete listing of Direct Sales, Distributor, and Sales Representative contacts, visit the Cirrus Logic web site at:
<http://www.cirrus.com/corporate/contacts/sales.cfm>

IMPORTANT NOTICE

"Preliminary" product information describes products that are in production, but for which full characterization data is not yet available. "Advance" product information describes products that are in development and subject to development changes. Cirrus Logic, Inc. and its subsidiaries ("Cirrus") believe that the information contained in this document is accurate and reliable. However, the information is subject to change without notice and is provided "AS IS" without warranty of any kind (express or implied). Customers are advised to obtain the latest version of relevant information to verify, before placing orders, that information being relied on is current and complete. All products are sold subject to the terms and conditions of sale supplied at the time of order acknowledgment, including those pertaining to warranty, patent infringement, and limitation of liability. No responsibility is assumed by Cirrus for the use of this information, including use of this information as the basis for manufacture or sale of any items, or for infringement of patents or other rights of third parties. This document is the property of Cirrus and by furnishing this information, Cirrus grants no license, express or implied under any patents, mask work rights, copyrights, trademarks, trade secrets or other intellectual property rights. Cirrus owns the copyrights of the information contained herein and gives consent for copies to be made of the information only for use within your organization with respect to Cirrus integrated circuits or other parts of Cirrus. This consent does not extend to other copying such as copying for general distribution, advertising or promotional purposes, or for creating any work for resale.

An export permit needs to be obtained from the competent authorities of the Japanese Government if any of the products or technologies described in this material and controlled under the "Foreign Exchange and Foreign Trade Law" is to be exported or taken out of Japan. An export license and/or quota needs to be obtained from the competent authorities of the Chinese Government if any of the products or technologies described in this material is subject to the PRC Foreign Trade Law and is to be exported or taken out of the PRC.

CERTAIN APPLICATIONS USING SEMICONDUCTOR PRODUCTS MAY INVOLVE POTENTIAL RISKS OF DEATH, PERSONAL INJURY, OR SEVERE PROPERTY OR ENVIRONMENTAL DAMAGE ("CRITICAL APPLICATIONS"). CIRRUS PRODUCTS ARE NOT DESIGNED, AUTHORIZED, OR WARRANTED TO BE SUITABLE FOR USE IN LIFE-SUPPORT DEVICES OR SYSTEMS OR OTHER CRITICAL APPLICATIONS. INCLUSION OF CIRRUS PRODUCTS IN SUCH APPLICATIONS IS UNDERSTOOD TO BE FULLY AT THE CUSTOMER'S RISK.

Cirrus Logic, Cirrus, and the Cirrus Logic logo designs are trademarks of Cirrus Logic, Inc. All other brand and product names in this document may be trademarks or service marks of their respective owners. BM, AT and PS/2 are trademarks of International Business Machines Corporation. Windows is a trademark of Microsoft Corporation. Lab Windows and CVI are trademarks of National Instruments. SPI™ is a trademark of Motorola. Microwire™ is a trademark of National Semiconductor.

2.7.2	Periods To Average Box	15
2.7.3	Start Button	15
2.8	Data Collection Window Overview	15
2.8.1	Time Domain / FFT / Histogram Selector	15
2.8.2	Collect Button	17
2.8.3	Config Button	17
2.8.4	Output Button	17
2.8.5	Zoom Button	17
2.8.6	Channel Select Buttons	17
2.9	Config Window	17
2.9.1	Number of Samples	17
2.9.2	Average	17
2.9.3	FFT Window	17
2.9.4	Histogram Bin Width	17
2.9.5	Pages to Collect	17
2.9.6	Data to Collect	17
2.9.7	Accept Button	18
2.10	Collecting Data Sets	18
2.11	Retrieving Saved Data From a File	18
2.12	Analyzing Data	18
2.13	Histogram Information	18
2.13.1	BIN	18
2.13.2	MAGNITUDE	18
2.13.3	MAXIMUM	18
2.13.4	MEAN	19
2.13.5	MINIMUM	19
2.13.6	STD. DEV.	19
2.13.7	VARIANCE	19
2.14	Frequency Domain Information	19
2.14.1	FREQUENCY	19
2.14.2	MAGNITUDE	19
2.14.3	S/D	19
2.14.4	S/N+D	19
2.14.5	SNR	19
2.14.6	S/PN	19
2.14.7	# of AVG	19
2.15	Time Domain Information	19
2.15.1	COUNT	19
2.15.2	MAGNITUDE	19
2.15.3	MAXIMUM	20
2.15.4	MINIMUM	20
3.	ADDENDUM	28
3.1	Board Modifications for Charge Pump	28

LIST OF FIGURES

Figure 1. Start-Up Window	10
Figure 2. Setup Window	11
Figure 3. Calibration Window	12
Figure 4. Conversion Window	13
Figure 5. Pulse Rate Output Window	14
Figure 6. Time Domain Analysis	15
Figure 7. FFT Analysis	16
Figure 8. Histogram Analysis	16
Figure 9. Analog Schematic	21
Figure 10. Digital Schematic Part 1	22
Figure 11. Digital Schematic Part 2	23
Figure 12. Power Supply Schematic	24
Figure 13. Silkscreen.....	25
Figure 14. Circuit Side.....	26
Figure 15. Solder Side.....	27
Figure 16. CDB5460A Modifications for A- Charge Pump	28

LIST OF TABLES

Table 1. Reference Selection	5
Table 2. Power Supply Connections.....	6
Table 3. Header, Jumper, and DIP Switch Descriptions.....	7
Table 4. DIP Switch S1 Setting.....	8

1. HARDWARE

1.1 Introduction

The CDB5460A evaluation board provides a quick means of evaluating the CS5460A Power Meter IC. The CDB5460A evaluation board's analog section operates from either a single +5 V or dual ± 2.5 V power supply. The evaluation board interfaces the CS5460A to an IBM™ compatible PC via an RS-232 interface. To accomplish this, the board comes equipped with an 80C51 microcontroller and a 9-pin RS-232 cable which physically interfaces the evaluation board to the PC. Additionally, analysis software provides easy access to the internal registers of the CS5460A, and provides a means to display the performance in the time domain or frequency domain.

1.2 Evaluation Board Overview

The board is partitioned into two main sections: analog and digital. The analog section consists of the CS5460A and a precision voltage reference. The digital section consists of the 80C51 microcontroller, 32 Kilobytes of SRAM, the hardware test switches, the reset circuitry, and the RS-232 interface. The board also has a user friendly power supply connection.

1.2.1 Analog Section

The CS5460A is designed to accurately measure and calculate: Energy, Instantaneous Power, I_{RMS} , and V_{RMS} while operating from a 4.096 MHz crystal. As shown in Figure 9 there are four BNC connectors (J6, J7, J8, J9) provided for converter input connections. A Shunt Sensor or Current Transformer can be connected to the converter's current inputs via J9 (IIN+) and J8 (IIN-). A voltage divider can be connected to the converter's voltage input via J6 (VIN+) and J7 (VIN-). Note, a simple RC network filters the sensor's output to reduce any in-

terference picked up by the input leads. The 3 dB corner of the filter is approximately 50 KHz differential and common mode.

The evaluation board provides three voltage reference options, on-chip, on-board and external, as shown in Figure 9. Table 1 illustrates the options available. With J18's jumpers in position REFOUT, the on-chip reference provides 2.5 volts. With J18's jumpers in position LT1019, the LT1019 provides 2.5 volts (the LT1019 was chosen for its low drift, typically 5 ppm/°C). By setting J18's jumpers to position REF+, the user can supply an external voltage reference to J26's REF+ and VA- inputs. Application Note 4 on the web (<http://www.cirrus.com/products//pubs.html>) details various voltage references.

Reference	Description	J18
LT1019	Selects on board LT1019 Reference (5ppm/°C)	<input checked="" type="radio"/> LT1019 <input type="radio"/> REF+ <input type="radio"/> REFOUT
REF+	Selects external reference	<input type="radio"/> LT1019 <input checked="" type="radio"/> REF+ <input type="radio"/> REFOUT
REFOUT	Selects the reference supplied by CS5460A	<input type="radio"/> LT1019 <input type="radio"/> REF+ <input checked="" type="radio"/> REFOUT

Table 1. Reference Selection

The CS5460A serial interfaces are *SPI™* and *Microwire™* compatible. The interface control lines (\overline{CS} , SDI, SDO, and SCLK) are connected to the 80C51 microcontroller via Port 1. To interface an external microcontroller, these control lines are also connected to J19 (Header 19). However to accomplish this, the evaluation board must be modified in one of three ways: 1) cut the interface control traces going to the microcontroller, 2) remove resistors 24, 23, 22, and 21, or 3) remove the microcontroller.

1.2.2 Digital Section

The schematics for the digital section are shown in [Figure 10](#) and [Figure 11](#). The digital section contains the microcontroller, test switches, a Maxim MAX3232 interface chip, and 32K bytes of SRAM, and one serial EEPROM. The test switches aid in debugging communication problems between the CDB5460A and the PC. The microcontroller derives its clock from a 20.0 MHz crystal. From this, The RS-232 data conversion IC (10) is configured to communicate via RS-232 at 9600 baud, no parity, 8-bit data, and 1 stop bit.

1.2.3 Power Supply Section

[Figure 12](#) illustrates the power supply connections to the evaluation board. The VA+ post supplies the positive analog section of the evaluation board, the LT1019 and the ADC. The VA- post supplies the negative analog voltage circuitry. Note, this terminal is grounded when powering the CDB5460A from a single +5 Volt analog supply. The VD+ post supplies the digital section of the ADC and level shifter. The Vu+ post supplies the digital section of the evaluation board, the 80C51, the reset circuitry, and the RS-232 interface circuitry. Note, the board's digital section supplied via Vu+ post, must

be +5 Volts only. [Table 2](#) shows the various power connections with the required jumper settings on J12 and J11.

1.3 Using the Evaluation Board

The CS5460A is a highly integrated device, containing dual ADCs with a computational unit. The CS5460A and CDB5460A data sheets should be read thoroughly and understood before using the CDB5460A evaluation board. The CS5460A contains a programmable gain amplifier (PGA), two $\Delta\Sigma$ modulators, two high rate filters, an on-chip reference, and power calculation engine to compute Energy, V_{RMS} , I_{RMS} , and Instantaneous Power. The PGA sets the input levels of the current channel at either 30 mV_{RMS} or 150 mV_{RMS} (for VREFIN = 2.5 V). The on-chip reference can provide the necessary 2.5 V reference. This output (VREFOUT) is used to supply the VREFIN pin with 2.5 V. The $\Delta\Sigma$ modulators and high rate digital filter allow the user to measure instantaneous voltage, current, and power at a output word rate of 4000 Hz when a 4.096 MHz clock source is used. [Table 3](#) describes the various headers, jumpers and DIP switches on the CDB5460A evaluation board. DIP switch S1 is used to control the 80C51. [Table 4](#) illustrates the varies setting of the DIP Switch S1.

Power Supplies		Power Post Connections					Jumpers	
Analog	Digital	VA+	VA-	GND	VD+	Vu+	J12	J11
+5V	+5V	+5	NC	GND	+5	NC	Vu+ ○ ○ VDDD VD+ ●● VDDD VD+ ○ ○ D+ VA+ ●● D+	VA- ○ ○ GND A- ●● GND
+5V	+3V	+5	NC	GND	+3	+5	Vu+ ●● VDDD VD+ ○ ○ VDDD VD+ ●● D+ VA+ ○ ○ D+	VA- ○ ○ GND A- ●● GND
±2.5V	+3V	+2.5	-2.5	GND	+3	+5	Vu+ ●● VDDD VD+ ○ ○ VDDD VD+ ●● D+ VA+ ○ ○ D+	VA- ○ ○ GND A- ○ ○ GND

Table 2. Power Supply Connections







Name	Function Description	Default Setting	Default Jumpers
J13	Used to switch VIN+ on the CS5460A between J6 and GND.	VIN+ Set to BNC J6	
J14	Used to switch VIN- on the CS5460A between J11 and GND.	VIN- Set to BNC J7	
J11	Used to switch VA-, A-, and GND. Refer to Table 2 on page 6	Negative Analog Power Supply Set to 0 V	
J18	Used to switch the VREFIN from external J26 header, to the on board LT1019 reference, or to the on-chip reference VREFOUT. Refer to Table 1, "Reference Selection," on page 5	VREFIN Set to on-chip reference VREFOUT	
J12	Used to switch VU+, VD+, and VA+ to VDDD and/or D+. Refer to Table 2, "Power Supply Connections," on page 6	Digital Power Supply Set to +5V	
J19	Used to connect an external micro-controller.	Connected to 80C51	NC
J17	Used in conjunction with the self test modes to test the UART/RS-232 communication link between the microcontroller and a PC.	RS-232 Set to Normal Mode	
J15	Used to switch IIN+ on the CS5460A between J10 and GND.	IIN+ Set to BNC J9	
J16	Used to switch IIN- on the CS5460A between J9 and GND.	IIN- Set to BNC J8	
J23	Used to switch XIN on the CS5460A to HDR6 when an external micro-controller is used.	XIN Set for on-board 4.096 MHz XTAL	
JP2	Used to connect PFMON pin on the CS5460A to monitor Power Supply VA+	PFMON Set Monitor VA+	
JP4	Used to connect the RESET Button to the CS5460A	RESET Set connected to CS5460A	
S1	DIP switch to control 80C51 (See Table 4) S1-1 is used to enable <i>auto-boot mode</i> S1-2 is used to select crystal to 80C51 S1-3 is used to select RS-232 test mode	S1-1 Auto-Boot off S1-2 Set 20 MHz S1-3 Set Normal	
J21	Allows LEDs D2 and D3 to indicate pulses on /EOUT and /EDIR. Pulse frequency must be less than ~6Hz to see light.	Disable LEDs	
J10	Used to disconnect XTAL1 input on microcontroller from off-board oscillator input.	Use on-board crystal	

Table 3. Header, Jumper, and DIP Switch Descriptions

80C51 Mode	S1
80C51 in Normal Operating Mode S1-1 OPEN S1-2 CLOSED 20 MHz Crystal S1-3 OPEN	
80C51 in Normal Operation Mode S1-1 OPEN S1-2 OPEN 11.059 MHz Crystal S1-3 OPEN	
80C51 in Test Mode S1-1 OPEN S1-2 CLOSED 20 MHz Crystal S1-3 CLOSED	
80C51 in Test Mode S1-1 OPEN S1-2 OPEN 11.059 MHz Crystal S1-3 CLOSED	
Auto-Boot Mode S1-1 CLOSED S1-2 CLOSED S1-3 OPEN	

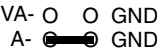
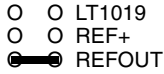
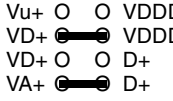
Table 4. DIP Switch S1 Setting

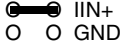
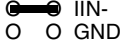
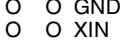
The S1-3 switch should be set to the OPEN position for normal operation. When testing the RS-232 link in the PC software, close S1-3. The S1-2 switch selects the crystal source for the 80C51. There are two crystal options available, 11.059 MHz and 20 MHz. If S1-2 is OPEN the 11.059 MHz crystal is selected, and when S1-2 is CLOSED the 20 MHz crystal is selected.

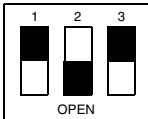
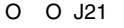
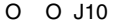
If S1-1 is closed, the CS5460A operates in *auto-boot* mode. When in auto-boot mode, a hardware reset (press on S2) will cause the CS5460A to boot up using the serial data from the serial EEPROM on the board (U9). The EEPROM must be programmed prior to the auto-boot sequence. The EEPROM does come pre-programmed with a valid boot-up sequence. This sequence programs the CS5460A for continuous conversion mode. If voltage and current signals are applied to the inputs, the CS5460A will issue pulses on the /EOOUT and /EDIR pins. Note that JP4 header must be shorted for auto-boot to work.

When the CDB5460 Evaluation Board is sent from the factory, the EEPROM is programmed with the following CS5460A command/data sequence:

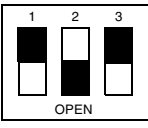
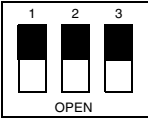
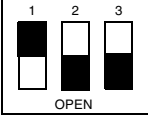
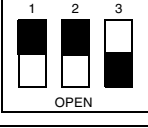
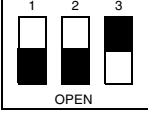
```

40 00 00 61 ;In configuration Register, turn high-
              pass filters on, set K = 1.
4C 10 00 00 ;Set Pulse Rate Register to 32768 Hz.
E8           ;Start continuous conversions.
78 00 01 00 ;Write stop bit to CS5460A to terminate
              autoboot sequence.
    
```

The auto-boot sequence runs with no assistance from the 8051 microcontroller. The user can verify this by disconnecting power from the board, pulling the microcontroller out of its socket, then power on again and run in auto-boot mode. See the CS5460A data sheet for more details on auto-boot.

2. SOFTWARE

The evaluation board comes with software and an RS-232 cable to link the evaluation board to the PC. The evaluation software was developed with Lab Windows/CVI™, a software development package from National Instruments. The software was designed to run under Windows 95™ or later, and requires about 3MB of hard drive space (2MB for the CVI Run-Time Engine™, and 1MB for the evaluation software). After installing the software, read the readme.txt file for any last minute updates or changes. More sophisticated analysis software can be developed by purchasing the development package from National Instruments (512-794-0100).

2.1 Installation Procedure

- 1) Turn on the PC, running Windows 95™ or later.
- 2) Insert the Installation Diskette #1 into the PC.
- 3) Select the Run option from the Start menu.
- 4) At the prompt, type: A:\SETUP.EXE <enter>.
- 5) The program will begin installation.
- 6) If it has not already been installed on the PC, the user will be prompted to enter the directory in which to install the CVI Run-Time Engine™. The Run-Time Engine™ manages executables created with Lab Windows/CVI™. If the default directory is acceptable, select OK and the Run-Time Engine™ will be installed there.
- 7) After the Run-Time Engine™ is installed, the user is prompted to enter the directory in which to install the CDB5460A software. Select OK to accept the default directory.
- 8) Once the program is installed, it can be run by double-clicking on the EVAL5460A icon, or through the Start menu.

Notes: The software is written to run with 640 x 480 resolution; however, it will work with 1024 x 768 resolution. If the user interface appears to be small, the user might consider setting the display settings to 640 x 480. (640x480 was chosen to accommodate a variety of computers).

2.2 Using the Software

Before launching the software, the user should set up the CDB5460A evaluation board by using the correct jumper and DIP switch settings as described in Part I, and connect it to an open COM port on the PC using the RS-232 serial cable. Once the board is powered on, the user can start the software package.

When the software is launched, the Start-Up window appears first (Figure 1). This window contains information concerning the software's title, revision number, copyright date, etc. At the top of the screen is a menu bar which displays user options. The menu bar item Menu is initially disabled to prevent conflicts with other serial communications devices, such as the mouse or a modem. After selecting a COM port, the Menu item will become available.

2.3 Selecting and Testing a COM Port

Upon start-up, the user is prompted to select the serial communications port which will interface to the CDB5460A board. To select the COM port, pull down the Setup menu option, and select either COM1 or COM2 (the DISK option is used for previously saved files, and is discussed later). Testing the COM port to verify communication between the PC and the evaluation board is not necessary, but can help to troubleshoot some problems. The procedure for testing the communication link follows.

- 1) Pull down the Setup menu option again, and select TEST RS-232.
- 2) When prompted, set DIP switch 1 (the leftmost DIP switch) to the closed position, reset the board, and press OK to perform the test.
- 3) If the test passes, set DIP switch 1 to the open position, and reset the board to return to normal operating mode.
- 4) If the test fails, check the serial port connections, power connections, jumpers, and DIP switch settings on the board, and run the test again from step 1.

Once the serial link is established between the PC and the evaluation board, the user is ready to access the internal registers of the CS5460A, collect data, and perform analysis on the collected data.

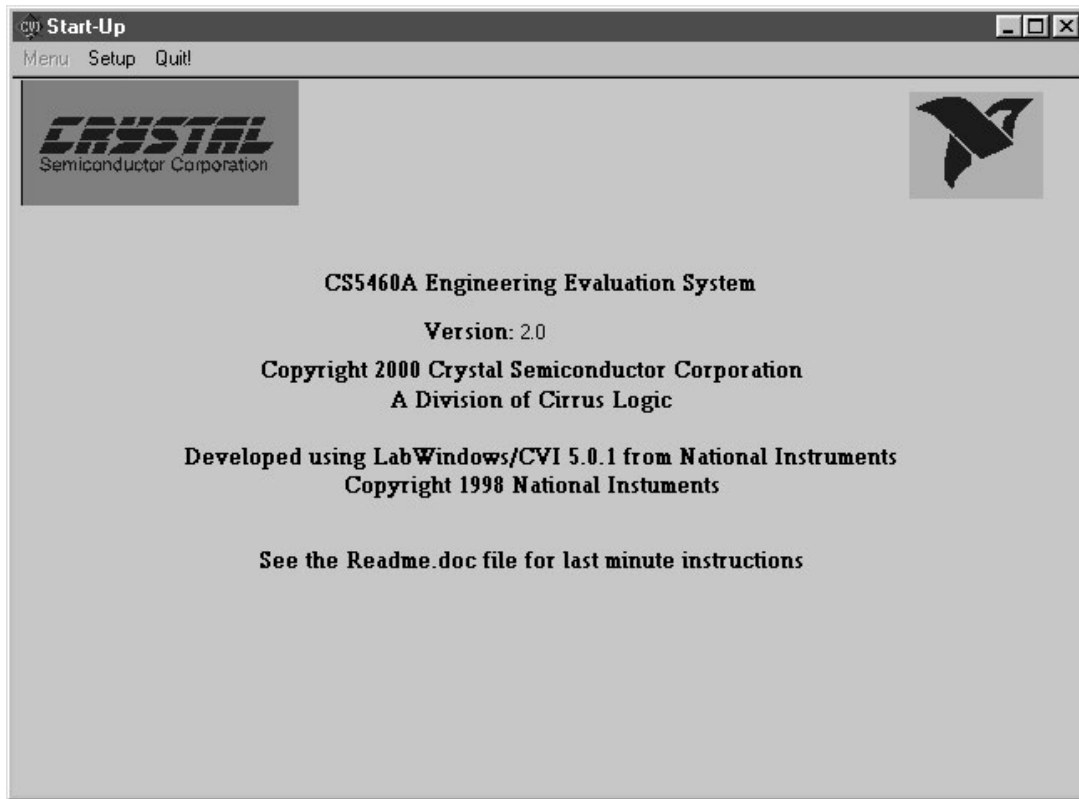

Figure 1. Start-Up Window

2.4 Register Access in the Setup Window

The Evaluation software provides access to the CS5460A's internal registers in the Setup Window (Figure 2). The user can enter the Setup Window by pulling down Menu and selecting Setup Window, or by pressing F2 on the keyboard.

In the Setup Window, all of the CS5460A's registers are displayed in hexadecimal notation, and also decoded to provide easier readability. Refer to the CS5460A data sheet for information on register functionality and meanings.

2.4.1 Refresh Screen Button

The Refresh Screen button will update the contents of the screen by reading all the register values from the part. This usually takes a couple of seconds, but it is a good idea to press the Refresh Screen button when entering the Setup Window, or after modify-

ing any registers to reflect the current status of the part.

2.4.2 CS5460A Crystal Frequency

The CS5460A accepts a wide range of crystal input frequencies, and can therefore run at many different sample rates. The crystal frequency being used on the CS5460A should be entered in this box to provide accurate frequency calculations in the FFT window. This will also help the software decide which functions can be performed reliably with the evaluation system.

2.4.3 Configuration Register

In the Configuration Register box, the contents of the Configuration Register can be modified by typing a hexadecimal value in the HEX: box, or by changing any of the values below the HEX: box to the desired settings. Note that when changing the

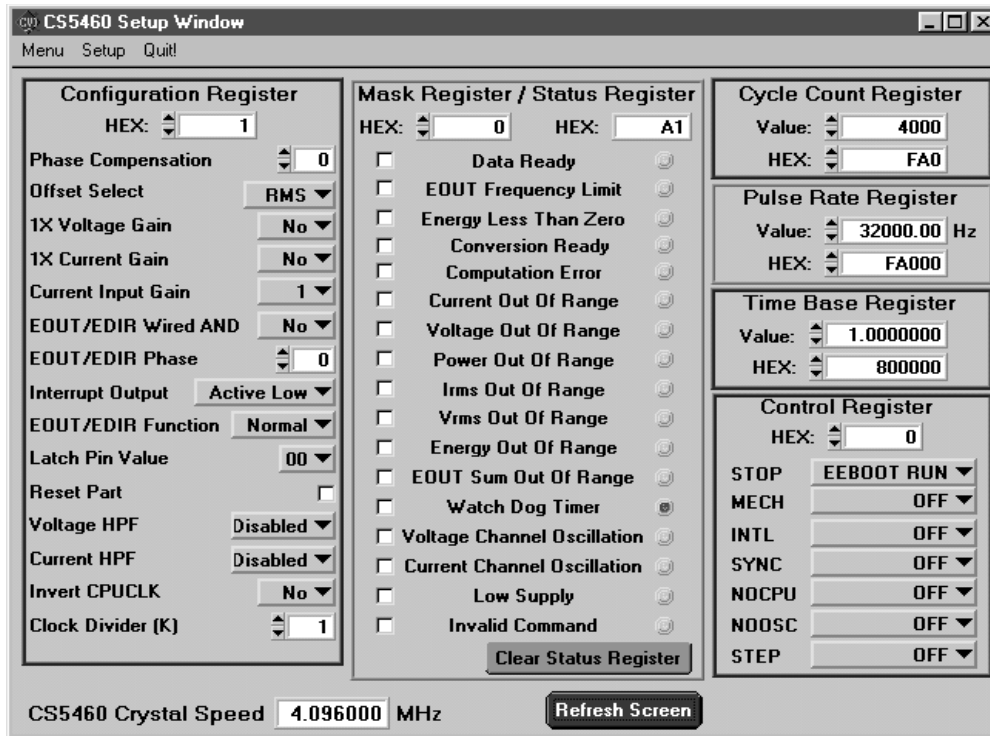

Figure 2. Setup Window

value of the reset bit to ‘1’ (RS, bit 7 in the Configuration Register), the part will be reset, and all registers will return to their default values. Press the Refresh Screen button after performing a reset to update the screen with the new register values.

Note: Although the CDB5460A software allows the user to modify any of the bits in the Configuration Register, changing certain bits may cause the software and board to behave erratically. For the evaluation system to function properly, the Interrupt Output function should be set to the default Active Low, and the Eout / Edir Function should be set to the default Normal. This applies only to the CDB5460A evaluation system, and not to the CS5460A chip itself.

2.4.4 Mask Register / Status Register

The Mask and Status Registers are displayed in hexadecimal and decoded in this box to show what each of the bits means. The Mask Register can be modified by typing a value in the HEX: box, or by

checking the appropriate check boxes for the bits that are to be masked. The Status Register cannot be directly modified. It can only be reset by pressing the Clear Status Register Button. The HEX: box for this register, and the LEDs are display only. A LED that is on means that the corresponding bit in the Status Register is set (except the Invalid Command bit, which is inverted).

Note: The value present in the Mask register may be changed by the software during certain operations to provide correct functionality of the CDB5460A board.

2.4.5 Cycle Count / Pulse Rate / Time Base Registers

These three boxes display the values of the Cycle Count, Pulse Rate, and Time Base Registers in both hexadecimal and decimal format. All three registers can be modified by typing a value in the corresponding Value: or HEX: box.

2.4.6 Control Register

The Control Register contains various bits used to activate or terminate various features of the CS5460A. Refer to the CS5460A data sheet for description of the bits. The user is able to turn each bit on or off individually. The value of the Control Register is displayed in HEX. Note that the Control Register, like all other CS5460A registers, is 24 bits long. Most of these bits are reserved or unused. Only the usable bits are displayed in the Setup Window.

2.5 Calibration Window

The Calibration Window is used to display and write to the CS5460A offset and gain calibration registers. The user is also able to initiate the CS5460A's calibration sequences that are used to set the calibration values. Both AC and DC calibrations can be run for offset and gain, for either the voltage channel or the current channel, or both simultaneously. The user should refer to the

CS5460A data sheet for more details on calibration.

2.5.1 Offset / Gain Register

In the Offset and Gain Register boxes, the offset and gain registers for both channels are displayed in hexadecimal and decimal. These registers can all be modified directly by typing the desired value in the hexadecimal display boxes. There are two types of offset registers: DC offset and AC offset. The AC offset registers only affect the RMS-register values. Note that the RMS offset registers only hold positive values between 0 and +1. The DC offset register is a two's complement number whose value ranges from -1 to +1.

2.5.2 Performing Calibrations

Offset and gain calibrations can be performed on both the voltage and current channels of the CS5460A. It is generally a good idea to software-reset the CS5460A before running calibrations, because the values in the calibration registers will affect the results of the calibration. A software reset

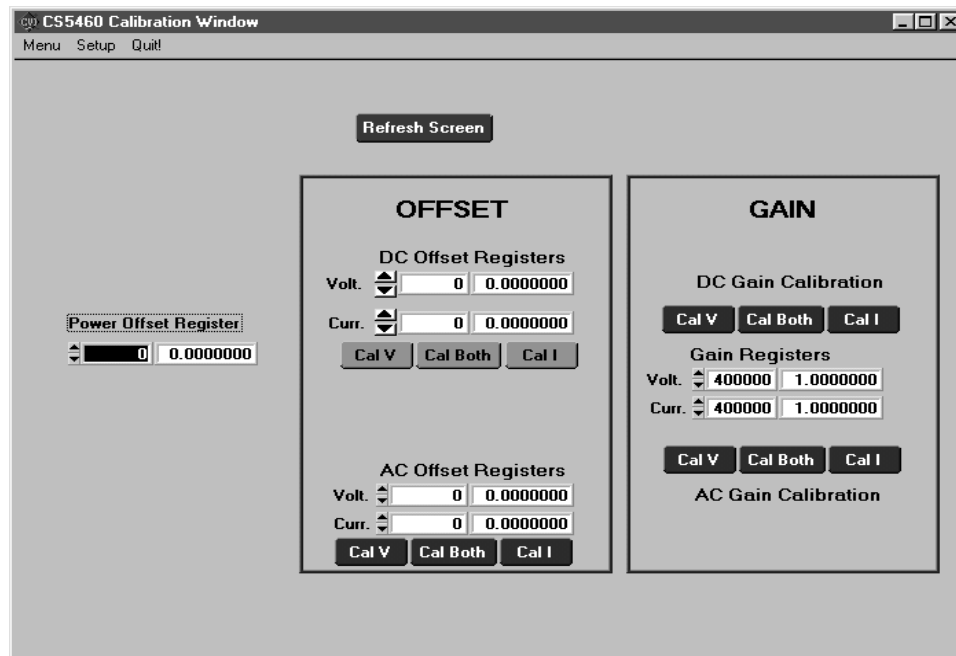

Figure 3. Calibration Window

will reset these registers back to the default values of zero offset and unity gain. Offset calibration should be performed before gain calibration to ensure accurate results.

2.5.2.1. Offset Calibrations:

- 1) Ground the channel(s) you want to calibrate directly at the channel header(s). HDR1 and HDR2 for the voltage channel, and HDR8 and HDR9 for the current channel. The channel(s) could also be grounded directly at the BNC connectors.
- 2) Press the corresponding AC or DC offset calibrate button (Cal V, Cal I, or Cal Both) in the Offset Register boxes.
- 3) The calibration value(s) will automatically update when the calibration is completed.

2.5.2.2. Gain Calibrations:

- 1) Attach an AC or DC calibration signal to the BNC connector(s), and make sure the corresponding channel headers (J13, J4, J15, and

J16) are set to the input position.

- 2) Press the corresponding AC or DC gain calibrate button (Cal V, Cal I, or Cal Both) in the Gain Register box.
- 3) The calibration value(s) will automatically update when the calibration is completed.

The Calibration Window also contains the Power Offset Register display and adjustment. The user can read and write the value in the Power Offset Register.

2.6 Conversion Window

The Conversion Window (Figure 4) allows the user to see the results of single and continuous conversions on all six data registers, perform data averaging, utilize the power-saving modes of the CS5460A, and reset the CS5460A's serial port. The Conversion Window can be accessed by pulling down the Menu option, and selecting Conversion Window, or by pressing F3.

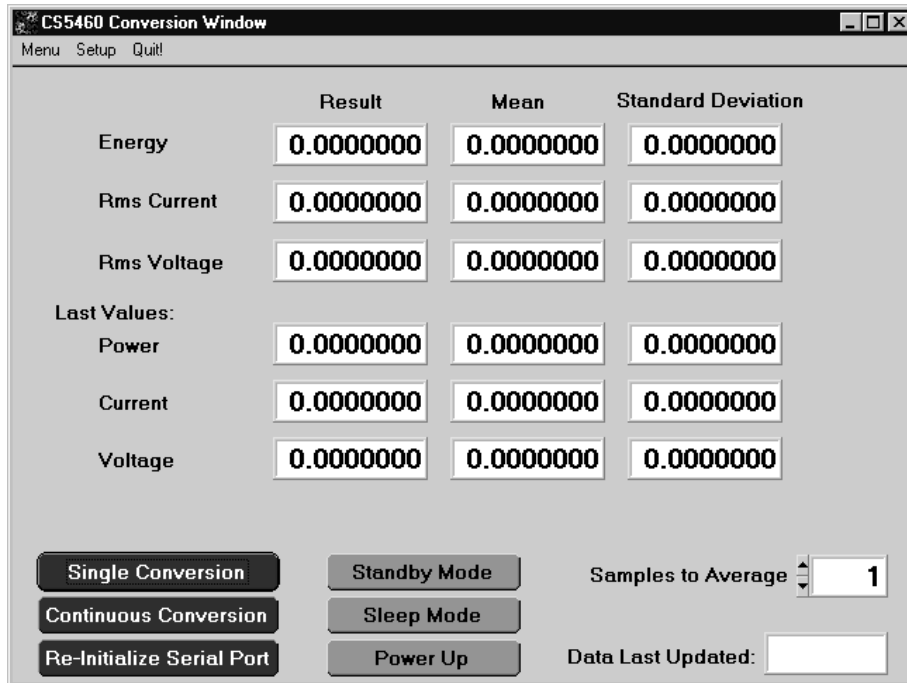

Figure 4. Conversion Window

2.6.1 Single Conversion Button

On pressing this button, single conversions will be performed repeatedly until the user presses the Stop button. After each conversion is complete, the Result data column will update with the values present in each data register. The Mean and Standard Deviation columns will update every N cycles, where N is the number in the Samples to Average box. Note that it can take many collection cycles after pressing the Stop button before the data actually stops being collected.

2.6.2 Continuous Conversions Button

This button functions similarly to the Single Conversion button, except that continuous conversions are performed instead. The data on the screen is updated in the same fashion, and the Stop button terminates this action. There are some speed limitations when performing this function, and if any of these limitations are exceeded, the user will be prompted to change some settings before proceeding.

2.6.3 Re-Initialize Serial Port Button

When this button is pressed, the software will send the synchronization sequence discussed in the

CS5460A data sheet to the part. This sequence brings the CS5460A's serial port back to a known state. It does not reset any of the registers in the part.

2.6.4 Standby / Sleep Mode Buttons

When these buttons are pressed, the part will enter either Standby or Sleep power saving modes. To return to normal mode, use the Power Up button.

2.6.5 Power Up Button

This button is used to send the Power Up/Halt command to the CS5460A. The part will return to normal operating mode and halt any conversions that are being done at this time.

2.7 Viewing Pulse Rate Output Data

The CS5460A features a pulse-rate energy output. The CDB5460A has the capability to demonstrate the functionality of this output in the Pulse Rate Output Window (Figure 5). The Pulse Rate Output Window can be accessed by pressing the F4 key, or by pulling down the Menu option, and selecting Pulse Rate Window.

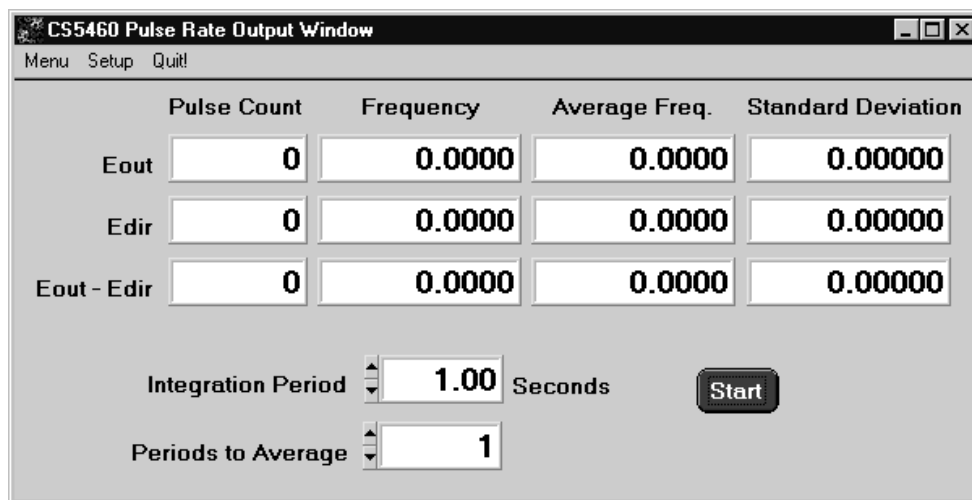

Figure 5. Pulse Rate Output Window

2.7.1 Integration Period Box

This box allows the user to select the length of time which pulses will be collected over.

2.7.2 Periods To Average Box

This box allows the user to average a number of integration periods together.

2.7.3 Start Button

When the Start button is pressed, the CDB5460A will capture pulse rate data according to the values in the Integration Period and Periods to Average boxes. After each integration period, the Pulse Count and Frequency columns will be updated. The Average Freq. and Standard Deviation columns will only be updated after all of the integrations have been collected. The software stops collecting data when the user presses the Stop button, or when the data collection is finished. Due to some speed

limitations of the on-board microcontroller, some higher pulse rates cannot be accurately collected. If the pulse rate is too high, a warning message will appear.

2.8 Data Collection Window Overview

The Data Collection Window (Figure 6, Figure 7, and Figure 8) allows the user to collect sample sets of data from the CS5460A and analyze them using time domain, FFT, and histogram plots. The Data Collection Window is accessible through the Menu option, or by pressing F5.

2.8.1 Time Domain / FFT / Histogram Selector

This menu selects the type of data processing to perform on the collected data and display in the plot area. Refer to the section on Analyzing Data for more information.

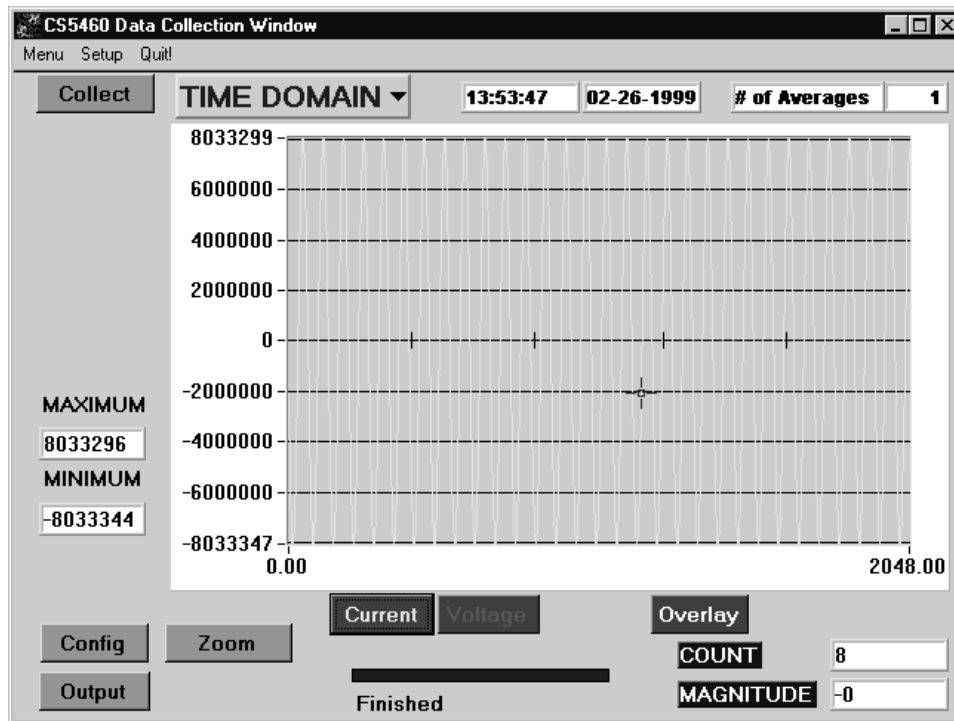

Figure 6. Time Domain Analysis

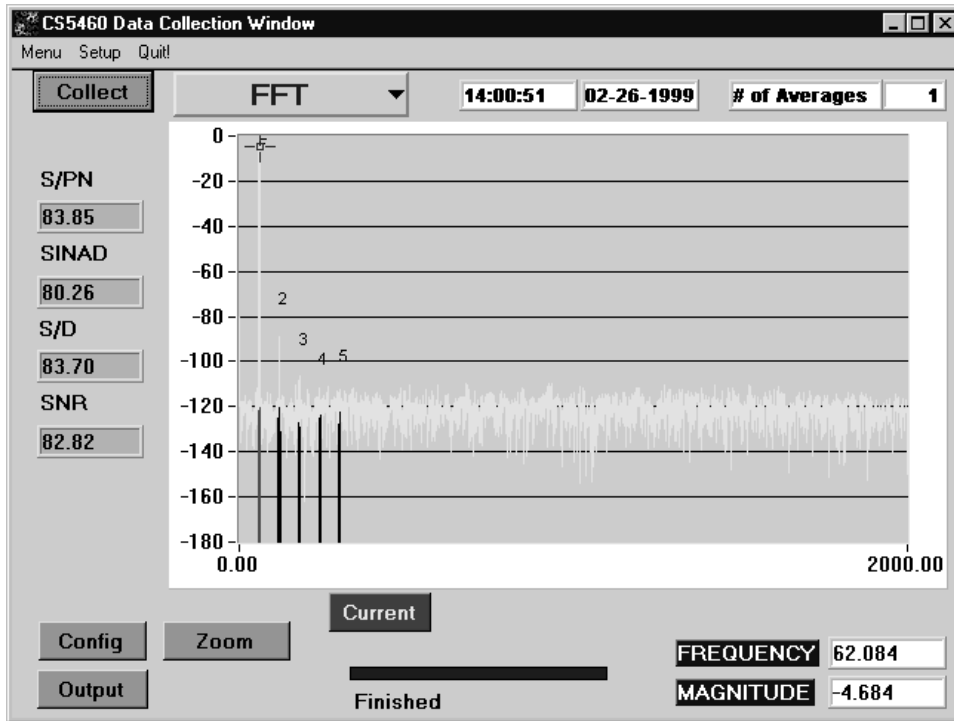

Figure 7. FFT Analysis

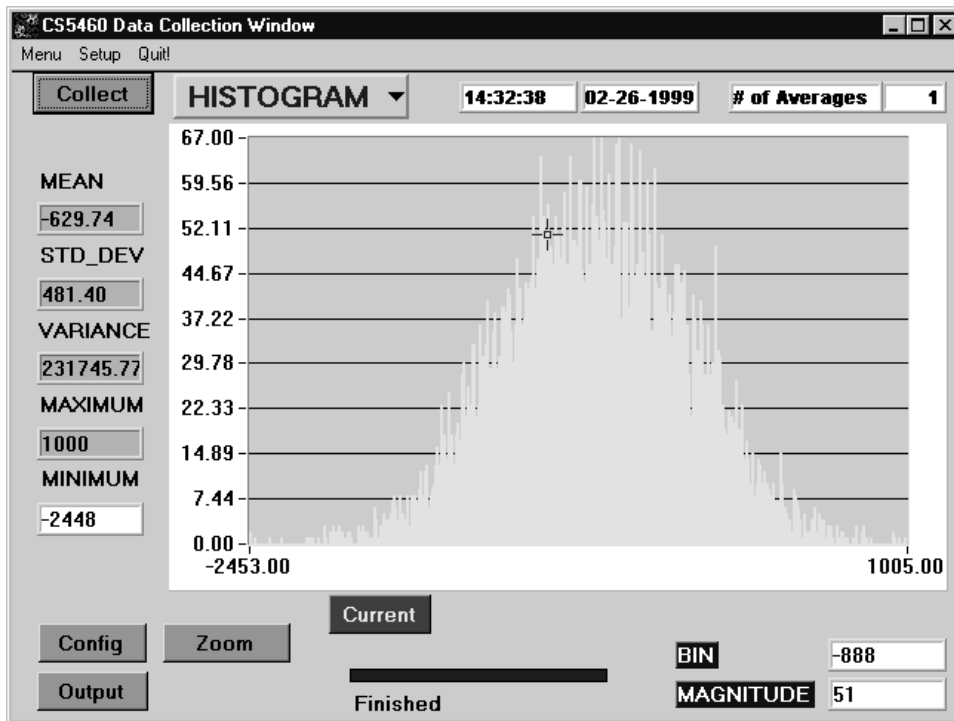

Figure 8. Histogram Analysis

2.8.2 Collect Button

This button will collect data from the part, to be analyzed in the plot area. See the section on Collecting Data Sets for more information.

2.8.3 Config Button

This button will bring up the configuration window, in which the user can modify the data collection specifications. See the discussion of the Config Window in this document.

2.8.4 Output Button

This button will bring up a window in which the user can output the data to a file for later use, print out a plot, or print out the entire screen.

Note: When saving data, only the data channel being displayed on the plot will be saved to a file.

2.8.5 Zoom Button

This button allows the user to zoom in on the plot by selecting two points in the plot area. Press the Restore button to return to the normal data plot, or press the Zoom button again to zoom in even further.

2.8.6 Channel Select Buttons

Depending on the number of channels of information that has been collected, between 1 and 3 channel select buttons will appear below the graph, allowing the user to choose the appropriate channel for display. In the Time Domain mode, an additional button labeled "Overlay" will be present, to allow the user to display all of the channels on the same plot.

2.9 Config Window

The Config Window allows the user to set up the data collection and analysis parameters.

2.9.1 Number of Samples

This box allows the user to select the number of samples to collect, between 16 and 8192. Due to

memory size on the CDB5460A, the maximum is 4096 samples when collecting two channels, and 2048 samples when collecting three channels.

2.9.2 Average

When doing FFT processing, this box will determine the number of FFTs to average. FFTs will be collected and averaged when the Collect button is pressed.

2.9.3 FFT Window

This box allows the user to select the type of windowing algorithm for FFT processing. Windowing algorithms include the Blackman, Blackman-Harris, Hanning, 5-term Hodia, and 7-term Hodia. The 5-term Hodia and 7-term Hodia are windowing algorithms developed at Crystal Semiconductor.

2.9.4 Histogram Bin Width

This box allows for a variable "bin width" when plotting histograms of the collected data. Each vertical bar in the histogram plot will contain the number of output codes contained in this box. Increasing this number may allow the user to view histograms with larger input ranges.

2.9.5 Pages to Collect

This box determines the number of data "pages" that the microcontroller will collect before sending data to the PC. Each page consists of the number of samples collected, and only the last page will be returned to the PC for processing. This function is useful at higher sampling frequencies to minimize board-level noise at the beginning of the conversion set.

2.9.6 Data to Collect

These six check boxes allow the user to select the data channels that will be collected and returned to the PC for processing. Up to three channels can be selected at once. There are some restrictions on the speed and number of samples to collect when selecting more than one channel. A warning message

will appear on pressing the Collect button in the Data Collection Window if any speed limits appear to be exceeded, but the data collection will still take place.

2.9.7 Accept Button

When this button is pressed, the current settings will be saved, and the user will return to the Data Collection Window.

2.10 Collecting Data Sets

To collect a sample data set:

- 1) In the Data Collection Window, press the Config button to bring up the Configuration Window and view the current settings.
- 2) Select the appropriate settings from the available options (see the section on the Configuration Window) and press the Accept button.
- 3) The Data Collection Window should still be visible. Press the Collect button to begin collecting data. A progress indicator bar will appear at the bottom of the screen during the data collection process.
- 4) Data is first collected from the CS5460A and stored in SRAM, and then transferred from the SRAM to the PC through the RS-232 serial cable. Depending on the value of the Cycle Count Register and the number of samples being collected, this process may take a long time. The process can be terminated by pressing the Stop button, but if this is done, the user should also press Reset on the CDB5460A board.
- 5) Once the data has been collected, it can be analyzed, printed, or saved to disk.

2.11 Retrieving Saved Data From a File

The CDB5460A software allows the user to save data to a file, and retrieve it later when needed. To load a previously saved file:

- 1) Pull down the Setup option and select Disk. A file menu will appear.

- 2) Find the data file in the list and select it. Press the Select button to return.
- 3) Go to the Data Collection Window, and press the Collect button.
- 4) The data from the file should appear on the screen. To select a different file, repeat the procedure.

2.12 Analyzing Data

The evaluation software provides three types of analysis tests - Time Domain, Frequency Domain, and Histogram. The Time Domain analysis processes acquired conversions to produce a plot of Magnitude versus Conversion Sample Number. The Frequency Domain analysis processes acquired conversions to produce a magnitude versus frequency plot using the Fast-Fourier transform (results up to $F_s/2$ are calculated and plotted). Also, statistical noise calculations are calculated and displayed. The Histogram analysis test processes acquired conversions to produce a histogram plot. Statistical noise calculations are also calculated and displayed.

2.13 Histogram Information

The following is a description of the indicators associated with Histogram Analysis. Histograms can be plotted in the Data Collection Window by setting the Time Domain / FFT / Histogram selector to Histogram (Figure 8).

2.13.1 BIN

Displays the x-axis value of the cursor on the Histogram.

2.13.2 MAGNITUDE

Displays the y-axis value of the cursor on the Histogram.

2.13.3 MAXIMUM

Indicator for the maximum value of the collected data set.

2.13.4 MEAN

Indicator for the mean of the data sample set. The mean is calculated using the following formula:

$$\text{Mean} = \frac{\sum_{i=0}^{n-1} X_i}{n}$$

2.13.5 MINIMUM

Indicator for the minimum value of the collected data set.

2.13.6 STD. DEV.

Indicator for the Standard Deviation of the collected data set. The Standard Deviation is calculated using the following formula

$$\text{StDev} = \sqrt{\frac{\sum_{i=0}^{n-1} (X_i - \text{Mean})^2}{n}}$$

2.13.7 VARIANCE

Indicates the Variance for the current data set. The variance is calculated using the following formula:

$$\text{Var} = \frac{\sum_{i=0}^{n-1} (X_i - \text{Mean})^2}{n}$$

2.14 Frequency Domain Information

The following describe the indicators associated with FFT (Fast Fourier Transform) Analysis. FFT data can be plotted in the Data Collection Window by setting the Time Domain / FFT / Histogram selector to FFT ([Figure 7](#)).

2.14.1 FREQUENCY

Displays the x-axis value of the cursor on the FFT display.

2.14.2 MAGNITUDE

Displays the y-axis value of the cursor on the FFT display.

2.14.3 S/D

Indicator for the Signal-to-Distortion Ratio, 4 harmonics are used in the calculations (decibels).

2.14.4 S/N+D

Indicator for the Signal-to-Noise + Distortion Ratio (decibels).

2.14.5 SNR

Indicator for the Signal-to-Noise Ratio, first 4 harmonics are not included (decibels).

2.14.6 S/PN

Indicator for the Signal-to-Peak Noise Ratio (decibels).

2.14.7 # of AVG

Displays the number of FFT's averaged in the current display.

2.15 Time Domain Information

The following controls and indicators are associated with Time Domain Analysis. Time domain data can be plotted in the Data Collection Window by setting the Time Domain / FFT / Histogram selector to Time Domain ([Figure 6](#)).

2.15.1 COUNT

Displays current x-position of the cursor on the time domain display.

2.15.2 MAGNITUDE

Displays current y-position of the cursor on the time domain display.

2.15.3 MAXIMUM

Indicator for the maximum value of the collected data set.

2.15.4 MINIMUM

Indicator for the minimum value of the collected data set.

Schematic & Layout Review Service

Confirm Optimum
Schematic & Layout
Before Building Your Board.

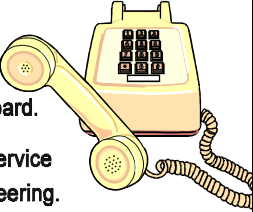

For Our Free Review Service
Call Applications Engineering.

C a l l : (5 1 2) 4 4 5 - 7 2 2 2

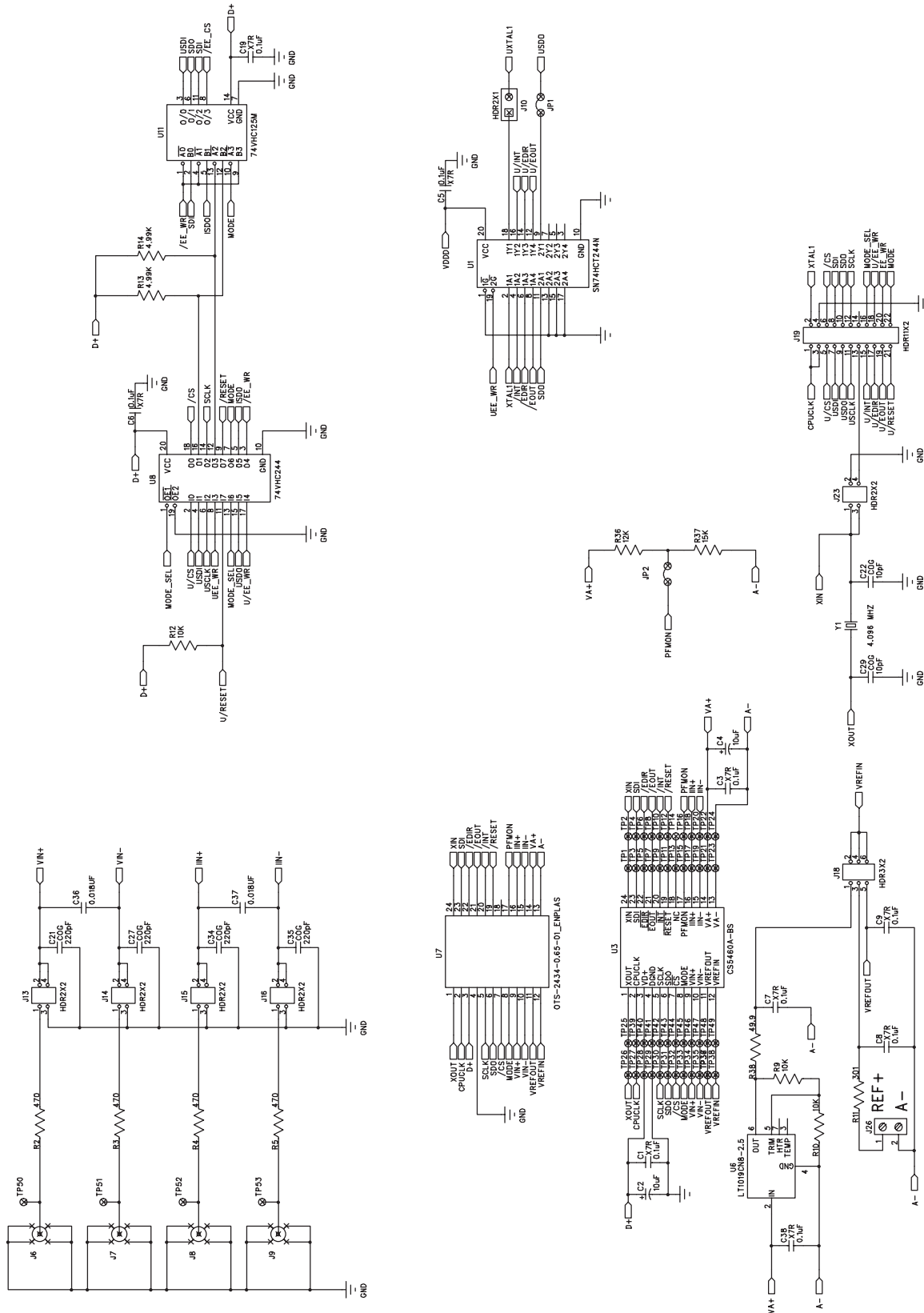
Figure 9. Analog Schematic

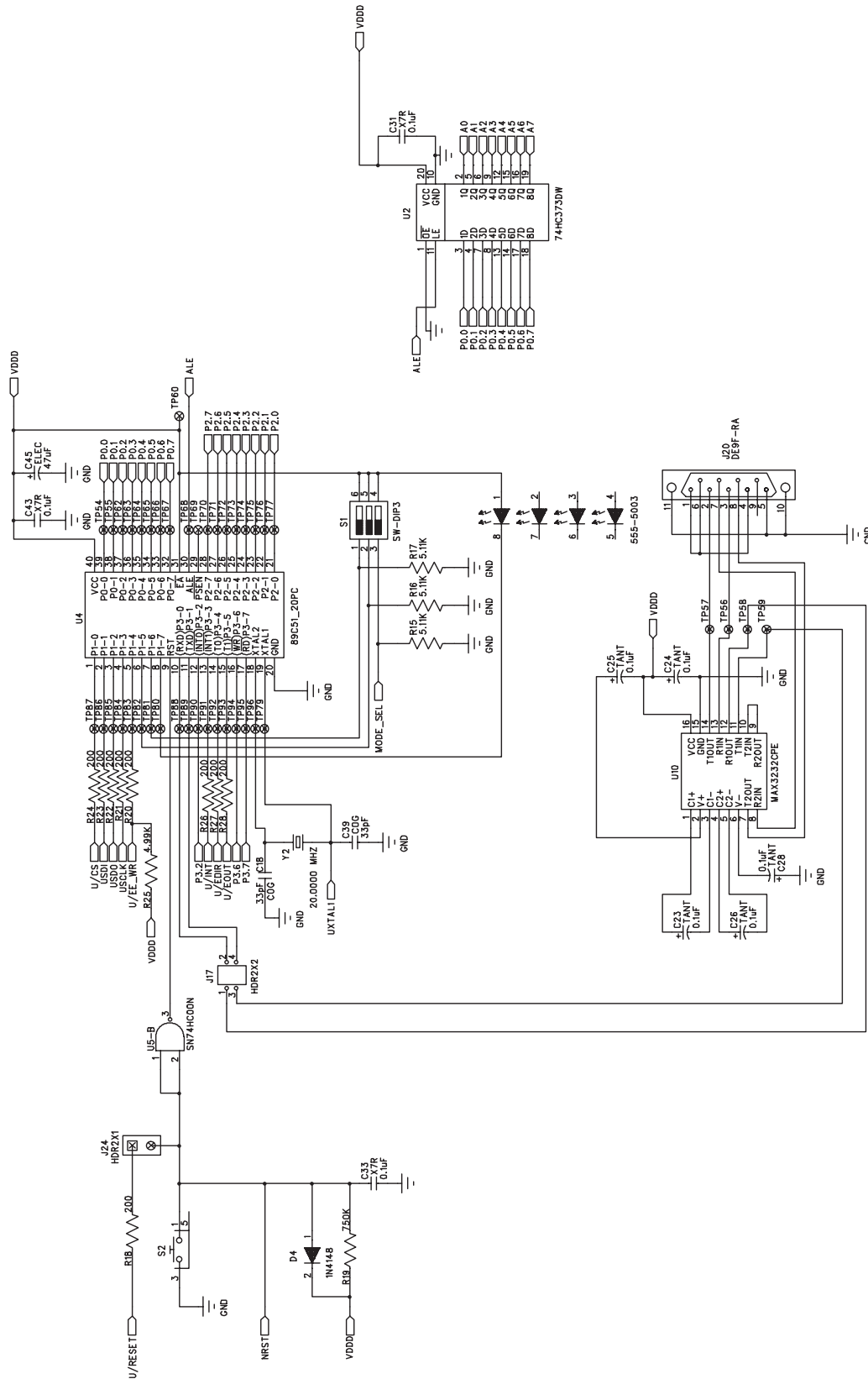
Figure 10. Digital Schematic Part 1

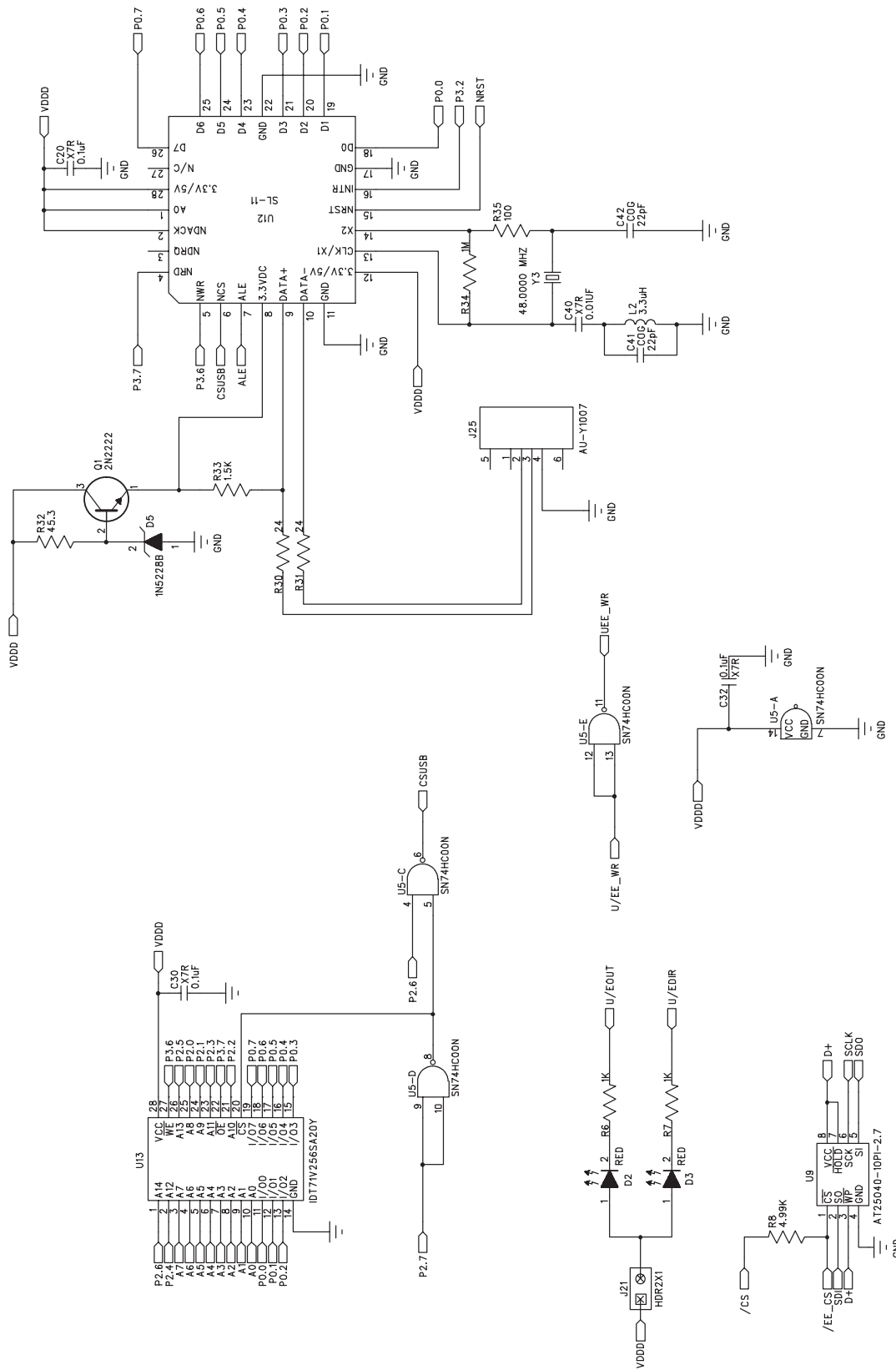
Figure 11. Digital Schematic Part 2

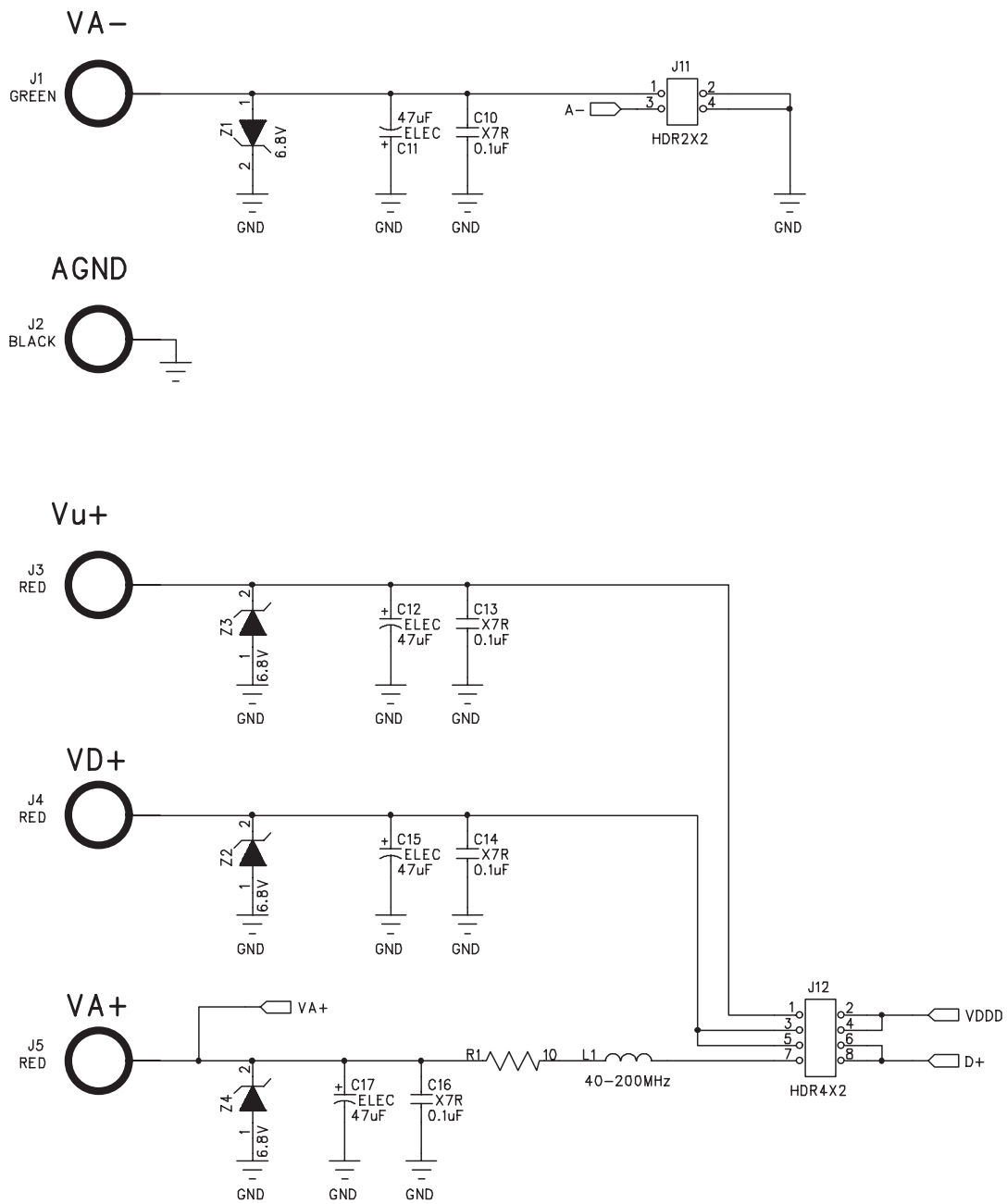
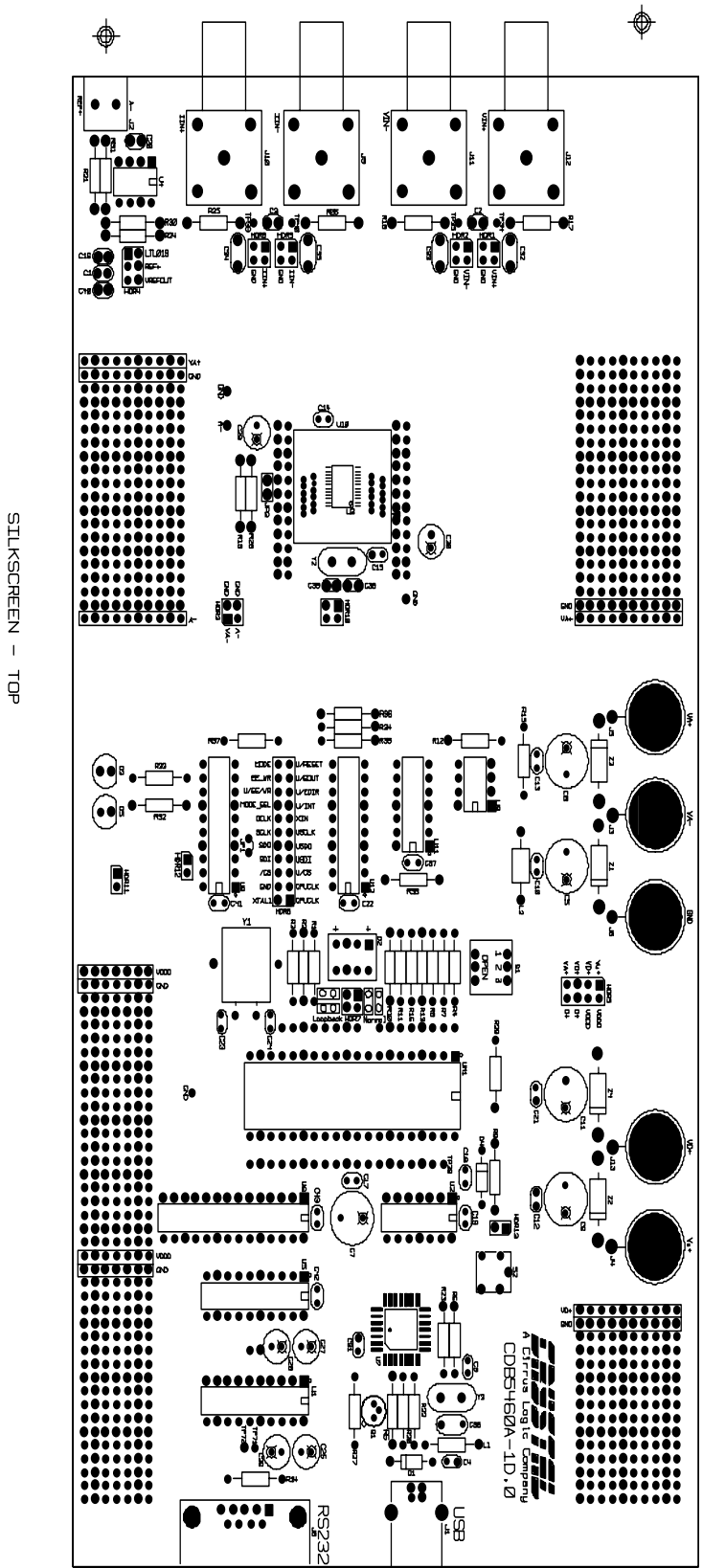

Figure 12. Power Supply Schematic



CRYSTAL SEMICONDUCTOR
 CDB5460 CUSTOMER DEMO BOARD
 CDB5460A-1D.0

SILKSCREEN - TOP

Figure 13. Silkscreen

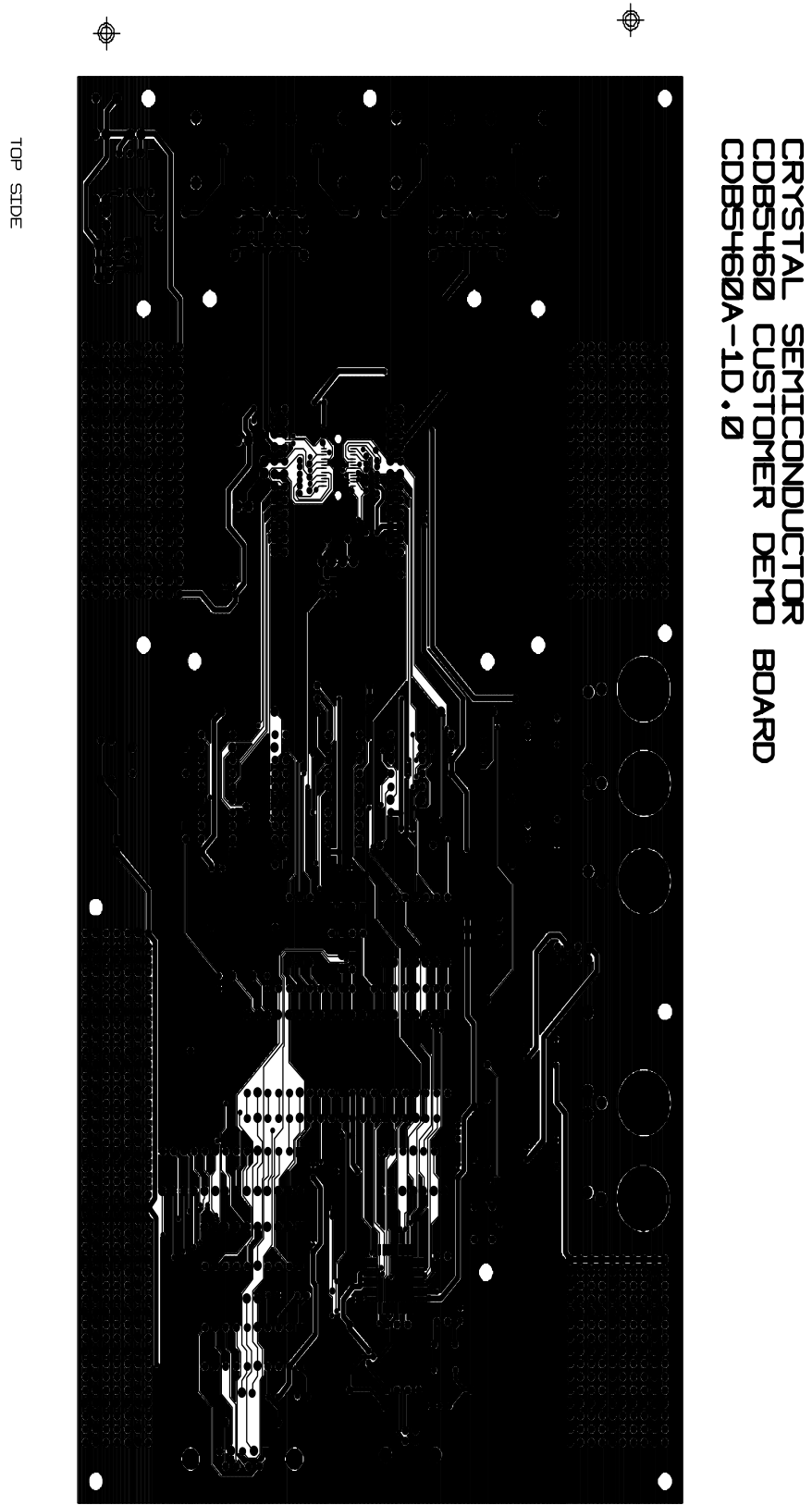
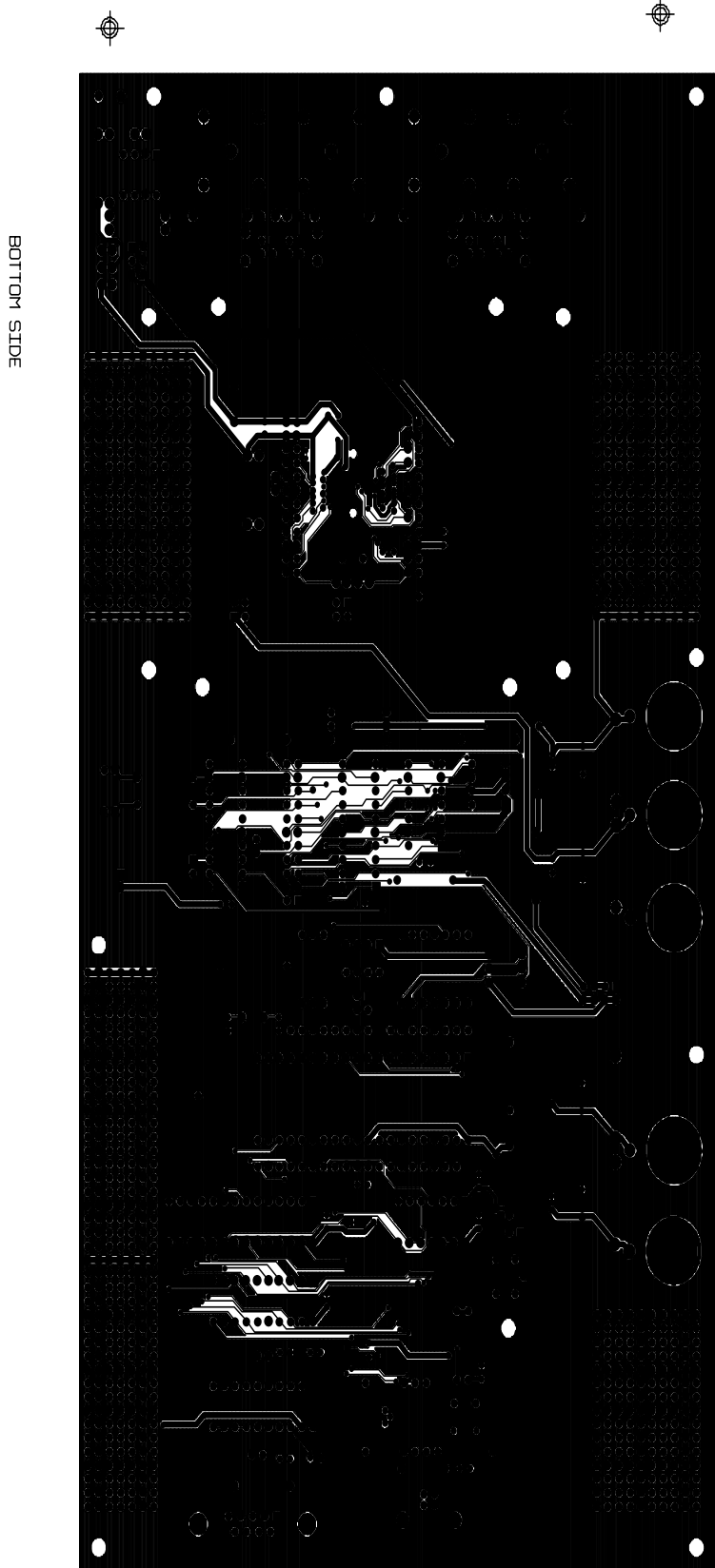

Figure 14. Circuit Side



CRYSTAL SEMICONDUCTOR
CDB5460 CUSTOMER DEMO BOARD
CDB5460A-1D.0

Figure 15. Solder Side

3. ADDENDUM

3.1 Board Modifications for Charge Pump

The CDB5460A can be modified by the user, to include a charge pump circuit, whose output could be used to supply the VA- supply pin in the +2.5V and -2.5V analog power configuration. The diagram below illustrates the schematic of such a circuit. The components must be added by the user.

- 1) Header H1 allows a clock source to be clipped across J1 with J2 open to analyze the charge pump by itself or drive it asynchronous to the CS5460A. With J1 open and J2 closed, the pump is clocked synchronously with the CS5460A. For best results, the charge pump should be clocked synchronously with the CS5460A.
- 2) The charge pump is constructed from components C1, C2, D1 and D2. D1 and D2 are BAT85 schottky diodes chosen for their speed and low forward voltage. Capacitor C1 provides the necessary current at 4.096 MHz. Capacitor C2 provides extra storage if the load on A- is increased. If the external reference is removed (and therefore the CS5460A is the only load on A-) C2 can be removed. The bypass capacitors from VA+ to A- will be sufficient.
- 3) Header H2 connects the charge pump to A-. H2 can be removed to analyze the unloaded performance of the charge pump. This should be closed for "charge-pump" mode operation.
- 4) A four-pin socket (U1) is added to connect an optional clock oscillator to the XIN pin and easily operate the CS5460A in "external clock" mode.

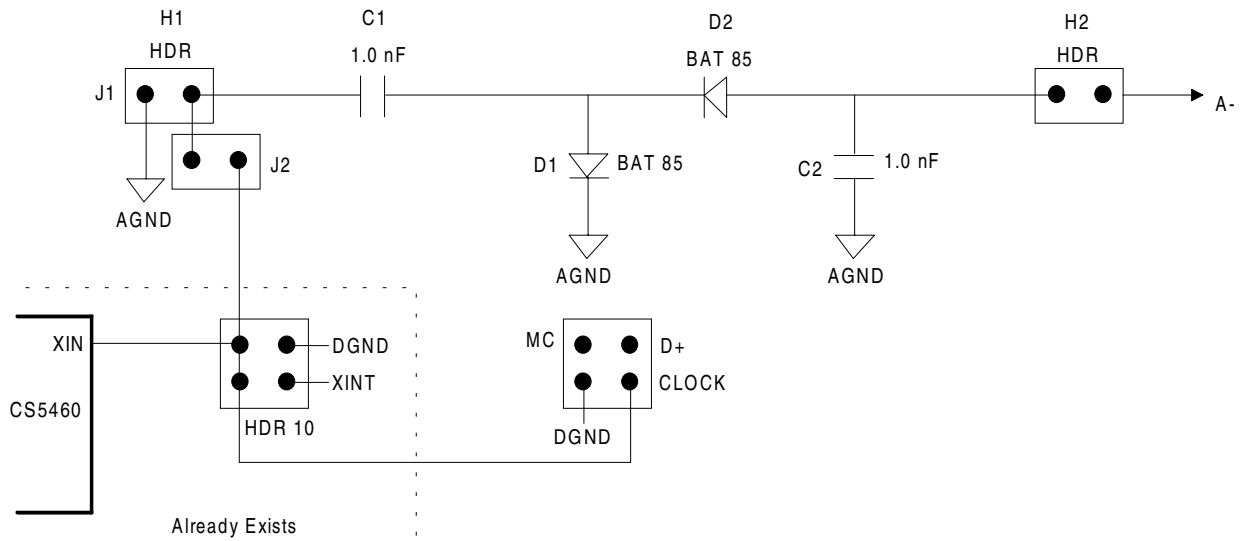

Figure 16. CDB5460A Modifications for A- Charge Pump